

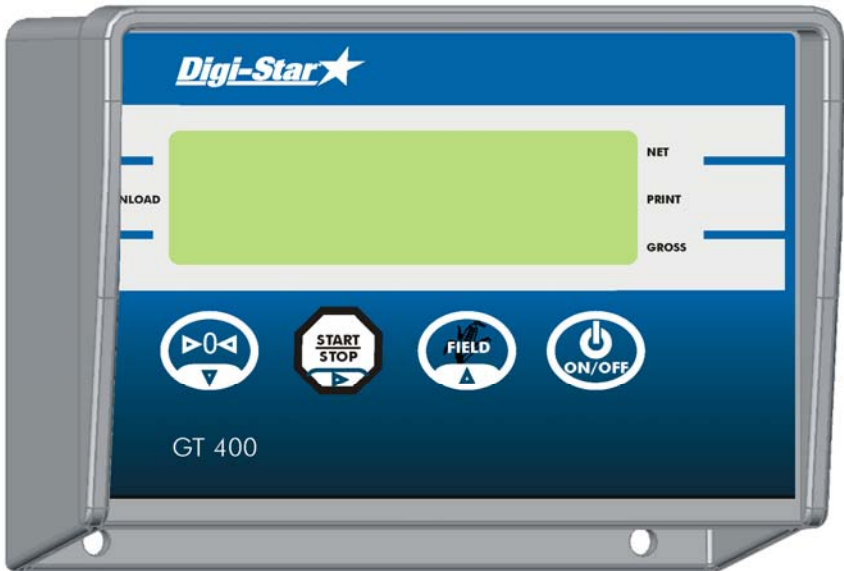

GT400

Operators Manual



Ft. Atkinson, Wisconsin USA



Panningen, The Netherlands

www.digi-star.com

TABLE OF CONTENTS

TECHNICAL SPECIFICATIONS	1
SAFETY DURING USE	2
Cleaning	2
Charging Battery and Welding	2
INDICATOR OVERVIEW	3
OPERATION	5
Turn on Indicator	5
Zero Balance Indicator	5
Loading and Unloading	6
Field ID	7
Print Formats	8
Saving/Printing Gross Weights	9
Turning Off the Indicator	9
WEIGHING ERRORS	10
Over-Capacity Limit (<i>OVRCAP</i>)	10
Over Range (<i>+RANGE</i>)	10
Under Range (<i>-RANGE</i>)	10
Low Battery Indication (<i>LO BAT</i>)	10
RUN SELF TEST	10
MENUS AND CALIBRATION	11
Changing Options Using Long Form Setup	11
SHORT FORM CALIBRATION	14
Obtain Current Set-up and Calibration Number	14
Calibrating Scale For Maximum Accuracy	15
Determining New Setup and Calibration Numbers	15
Enter A New Setup And Calibration Number	16
INSTALLATION	17
Indicator Mounting	17
Optional Ram Mounting	17
Cable Connection	18
Indicator Connection Diagram	18
Bottom Panel Cable Connections	18
Connect Load Cells to J-Box	19
Load Cell Direction	19
Indicator Calibration	19
OPTIONAL EQUIPMENT	20
Data Transfer Options	20
Remote Indicators	20
TROUBLESHOOTING	21

All rights reserved. Reproduction of any part of this manual in any form whatsoever without Digi-Star's express written permission is forbidden. The contents of this manual are subject to change without notice. All efforts have been made to assure the accuracy of the contents of this manual. However, should any errors be detected, Digi-Star would greatly appreciate being informed of them. The above notwithstanding, Digi-Star can assume no responsibility for errors in this manual or their consequence.

© Copyright! 2009 Digi-Star, Fort Atkinson (U.S.A).

TECHNICAL SPECIFICATIONS

SIZE

7.33" long x 5.25" high x 3.38" wide (186mm x 133mm x 85mm)

WEIGHT

2 lbs (.91 Kg)

HELP MESSAGES

Context sensitive help messages in 10 languages
Long messages are scrolled

TRANSDUCER EXCITATION

8 volts D.C. Nominal
Capable of driving eight 350 Ohms transducers
Short circuit proof

ATC

Auto Temperature Compensation of the internal circuitry for high accuracy weighing measurements

TRANSDUCER SIGNAL

Compatible with transducers having full scale indicator transfer characteristics greater than 0.25 mv/v

"AUTO RANGE"

(Selectable) To increase display counts at weight values of 300 and 600 display counts.

CONNECTOR

AMP plastic weather resistant circular connector. Gold contacts.

POWER REQUIREMENTS

10.5 to 16.0 V.D.C.
160 mA nominal with four 350Ω L.C.

SET UP AND CALIBRATION

Via front panel

GROSS RANGE

999,999 max. display

LOW BATTERY WARNING

Enabled at 10.5V nominal

POUND/KILOGRAM

Selectable

DISPLAY

STD EZ 6 Digit LCD 1.0. high

DISPLAY RESOLUTION

.01, .02, .05, .1, .2, .5, 1, 2, 5, 10, 20, 50, 100

DISPLAY UPDATE RATE

Selectable: 1, 2, 3, 4 times/sec.

MAX. DISPLAY RESOLUTION

Adjustable to 40,000 counts max.

ZERO TRACKING

Selectable, On/Off

SPAN ACCURACY

$\pm(.1\% + .005\%/^{\circ}\text{F})$ or $(.1\% + 0.009\% ^{\circ}\text{C})$ full scale ± 1 output count

MOTION DETECTION

Selectable, On/Off

ZERO ACCURACY

$(.005\%/^{\circ}\text{F})$ or $(0.009\% ^{\circ}\text{C})$ full scale ± 1 output count for 0.5 mv/v transducer

ENVIRONMENTAL ENCLOSURE

IP65, IEC 529

WEIGH ALGORITHM

4 internally selectable digital filters to optimize performance
(General, Slow, Fast and Lock-on)

NON-VOLATILE MEMORY

EEPROM for balance

OPERATING TEMP

-29°C to 60°C -20°F to 140°F

SAFETY DURING USE



Caution

Cleaning

Do not use running water (high pressure cleaners, hoses) to clean the indicator.

Charging Battery and Welding



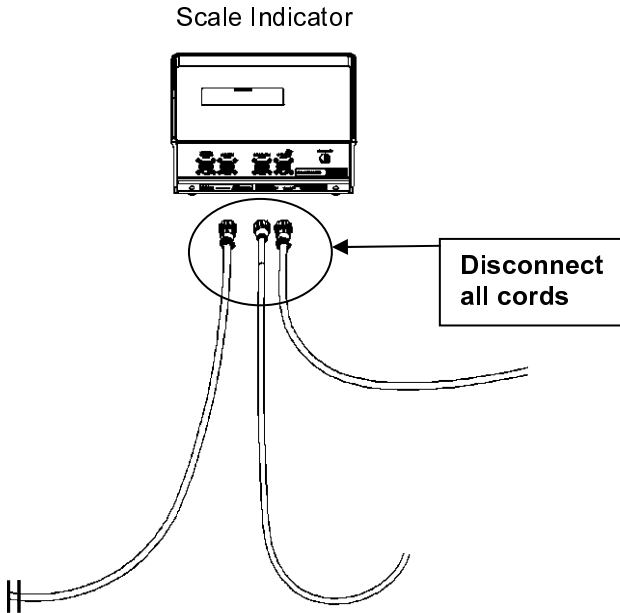

Disconnect all cables from the weighing indicator before charging the battery or welding on the machine. If cables are left connected, the weighing indicator and connected load cells could be damaged.

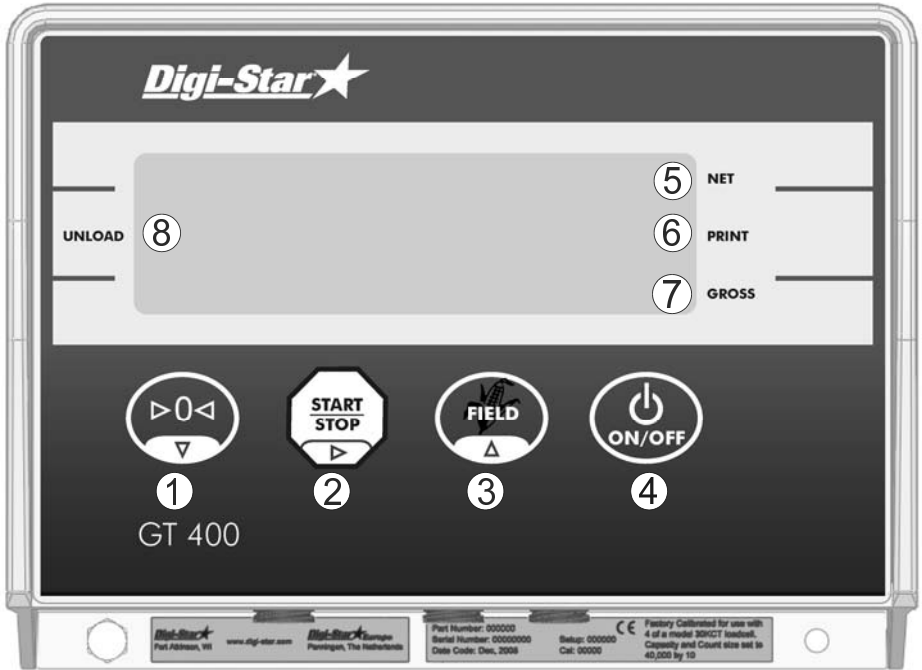

INDICATOR OVERVIEW



Note: See page 17 for installation instructions.

- ①  - ZERO/BALANCE operation when the scale is empty.
- ②  - start unloading and stop unloading, indicator displays amount unloaded, stores or prints data to serial port when complete.
- ③  - edit name and display weight accumulation value.
- ④  - turns the unit on and off.
- ⑤ Net – arrow flashes in net mode.
- ⑥ Print – arrow flashes when printing or saving to Data-Down-Loader.
- ⑦ Gross – arrow flashes in gross mode.
- ⑧ Unload – arrow flashes in unload mode.

Bottom Panel

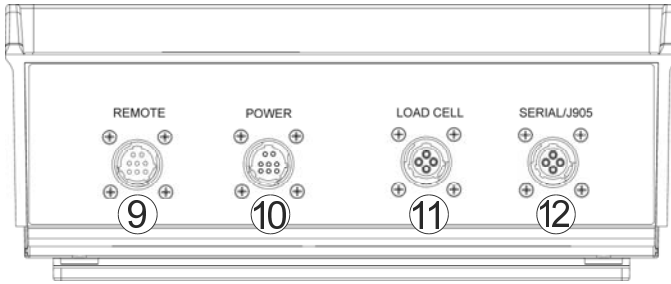

- ⑨ - Remote Port – Optional, for remote display.
- ⑩ - Power Cord Connection – +12 VDC.
- ⑪ - Load Cell Connection – Connect cable from the J-Box.
- ⑫ - Serial/J905 – Optional, to communicate with computer and other digital Input/Output devices.

Pin	J905 Connector Signals
1	+5VDC
2	Com #1 Out (Tx) - Computer
3	Com #1 In (Rx) - DDL & Computer
4	Com #2 Out (Tx) - Printer
5	+12 VDC
6	Gnd – Available for any Com device
7	Com #2 In (Rx)
8	Ground

OPERATION

Turn on Indicator



1. Press .

Zero Balance Indicator

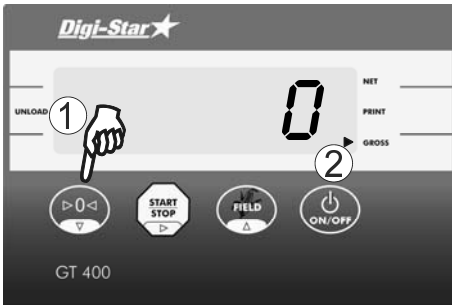



1. Press and hold  for 3 seconds to zero balance indicator.
2. Flashing arrow points to gross next to the display window, indicator ready to weigh.

Loading and Unloading

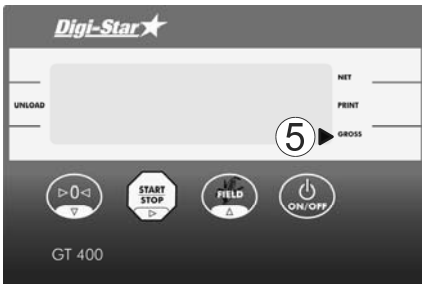
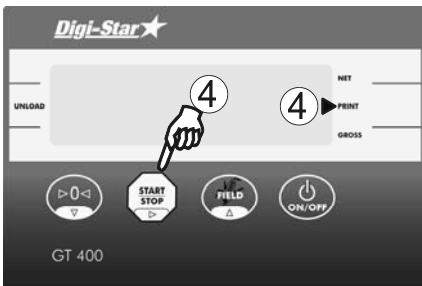
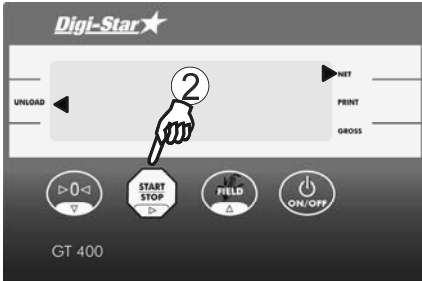
Note: For best accuracy park scale on level surface and allow weight reading to stabilize before Zero balancing the scale and before beginning to unload.







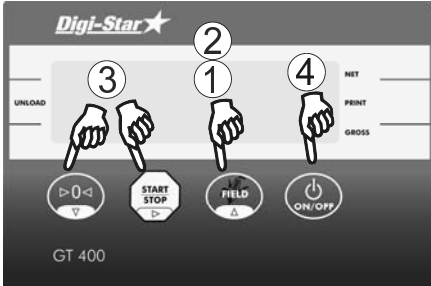

1. Load cart.
 2. Press  to begin unloading. Display reads Zero. Arrows point to Net and Unload.
 3. Unload weight from cart. Display shows amount unloaded.
 4. Press  after unloading is complete. Data is automatically added to accumulator and saved to printer or DDL (See print format section, page 8); a flashing arrow will point to PRINT.
- Note: Print and accumulator features are available with Serial Option only.*
5. Indicator displays GROSS weight remaining on scale.

Field ID

6 character identification value stored in internal memory of indicator to identify field being unloaded, truck being loaded or other information.



1. Press . *FIELD* is displayed and a flashing cursor or character is displayed in the first position.
2. Press  to scroll available characters. Hold  for 4 seconds to increase second scroll rate.
3. Press  to scroll backwards through available characters. Press  to move to the next character.
4. Press  to accept and save.

Print Formats

Three print formats are available to output *PRTACC* value and *FIELD ID* to DDL or printer.

PRTAC1: *FIELD ID, 4856, GR, 274575, PA, 05FE08, 1:44P*

PRTAC2: *FIELD ID, 05FE08, 1:44P*
 4856, GR, 274575, PA

Includes following information:

- Field ID
- Weight
- Weight Tag (NE, GR, Load/Unload)
- Accumulated Weight
- Print Accumulator Tag
- Date and Time

PRTAC3: *FIELD3, 5977, LB, ,GR, 309719,PA,05FE08, 4:42P*

Includes above and adds "Unit of Measure".

See "Menus and Calibration" (see page 11) to change print format (PRTFMT).

Saving/Printing Gross Weights

(Optional w/ Serial Option)

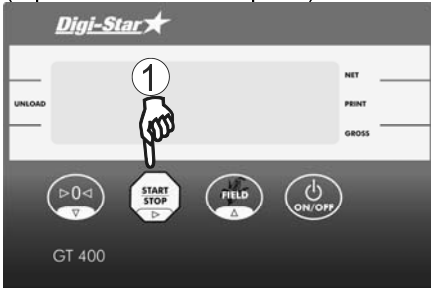

1. Press and hold  three seconds to send weight to serial port.

Each time this command is executed the value displayed is added to the "PRTACC" which is the accumulated weight. Weight is accumulated until cleared.

Turning Off the Indicator

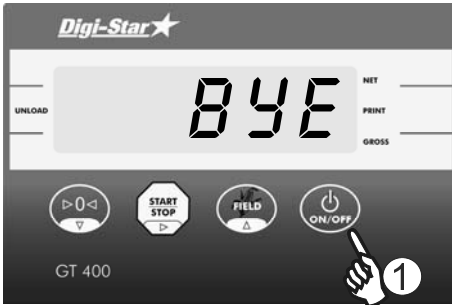

1. Press  until "BYE" is displayed.

WEIGHING ERRORS

Over-Capacity Limit (OVRCAP)

The display shows the message "OVRCAP" if the weight on the scale system exceeds the capacity limit. The capacity value is entered in SETUP to warn of overloading the scale system.

Over Range (+RANGE)

The display shows the message "+RANGE" if the weight on the scale system exceeds the maximum weight measurable by the scale system. The over range value is always the system's maximum A/D counts multiplied by the scaling factor. The actual weight at which over range occurs depends on the calibration, zero, and display count size.

Under Range (-RANGE)



The display shows the message "-RANGE" if the weight on the scale system is less than the minimum weight measurable by the scale system. The under range value is always the system's minimum A/D counts multiplied by the scaling factor. The actual weight at which under range occurs will depend on the; calibration, zero, and display count size.

Low Battery Indication (LO BAT)

If the supply voltage drops below the (10.5 Volts), the message *RECHARGE BATTERY - TURNING OFF* and *LO BAT* will periodically show on the display to alert the operator of the low battery condition.

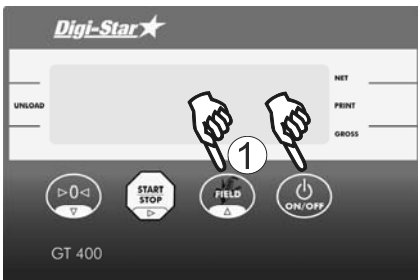
RUN SELF TEST



1. Press  3 seconds until the LB symbol starts to blink. Release.
2. Press  to start the Self Test.

MENUS AND CALIBRATION

The Indicator has optional settings that allow flexibility in the way that the scale is used and data is collected.

Changing Options Using Long Form Setup

Enter Long Form Setup by holding  and  for three seconds.



Press  to advance to desired menu 1,2,3,4,CALIB, or EXIT,

press  to select.

Press  to advance to desired setting.





Press  to advance setting to desired option.

Press  to save setting option and advance to next setting.

Hold  and press  to return to normal indicator operation.

Default settings from the factory vary with options and due to customer preferences.

SETTING [display]	OPTIONS [display] BOLD=DEFAULT	DESCRIPTION
MENU 1. BASIC FEATURES IN MOST INDICATORS		
LANGUAGE (LANGAG)	English Dutch French German Italian Portuguese Spanish Danish Hungarian Spanish	<i>(ENGLISH)</i> <i>(NEBERL)</i> <i>(FRANCS)</i> <i>(DEUTSH)</i> <i>(ITAL)</i> <i>(PORT)</i> <i>(ESPAÑ)</i> <i>(DANSK)</i> <i>(MAGYAR)</i> <i>(VESTA)</i> Select language to be displayed.
DISPLAY RATE (D RATE)	1,2,3,4	Update display times per second.
FIELD ID (FIELD)	NEW EZ	Identity of FIELD location, Truck ID or Grain Cart ID.

SETTING [display]	OPTIONS [displayed] BOLD=DEFAULT	DESCRIPTION
MENU 2. CLOCK, PRINTER, COMMUNICATIONS & ESTIMATED WEIGHT FEATURES		
TIME FORMAT (TIME F)	<i>24 HR</i> <i>AM/PM</i>	Select time format -AM/PM or 24 hour
TIME (TIME)	<i>XX:XX:XX</i>	 changes time.  selects hh,mm,or:ss.
DATE FORMAT (DATE F)	1-mm-dd 2-mm/dd/yy 3-mm/dd/yyyy 4-dd-mm 5-dd/mm/yy 6-dd/mm/yyyy 7-ddmoyy 8-ddmoyyyy.	Select date format
DATE (DATE)	Enter XXXXXX	 changes date –  moves to next field.
TARE AUTO PRINT (TAREAP)	<i>ON/OFF</i>	If ON -tare auto-prints displayed weight.
ONE LINE PRINT (1L PRT)	<i>ON/OFF</i>	If ON -indicator data prints on one line.
AUTO PRINT (APRINT)	<i>ON/OFF</i>	If ON -pressing keys auto-prints weight values.
INTERFACE (COM IN)	<i>DOWNLO</i> , <i>EZ CAD</i> , <i>EZ2CAD</i>	Com port interface selections <i>DOWNLO</i> for Data Down Loader, <i>EZ</i> <i>EZ CAD</i> = Original EZ Commands, <i>EZ2CAD</i> = EZII Escape Commands.

SETTING [display]	OPTIONS [display] BOLD=DEFAULT		DESCRIPTION
PRINT FORMAT (PRTFMT)	<i>AUTO</i> <i>WTONLY</i> <i>DOWNLD</i> <i>DT+TM</i> <i>ID+TM</i> <i>IDWTTM</i> <i>ANIMAL</i> <i>3200-A</i> <i>3200-B</i> <i>32-TMR</i> <i>DATCHI</i> <i>FDINFO</i>	<i>WTRCTM</i> <i>EIDINF</i> <i>EID</i> <i>EIDVID</i> PRTAC1 <i>PRTAC2</i> <i>PRTAC3</i> <i>FEED-1</i> <i>PRTAC4</i> <i>PRTAC5</i> <i>PRTAC6</i> <i>BUFINF</i>	Select alternate & comma (CSV) formats.
(ZEROUT)			Perform the Zero/Balance for SCOREM #11 weight output and Analog Output Option (4-20mA).
(C1 DLY)	<i>OFF, .10, .25, .50, .75, 1-5</i>		Choose the number of seconds the printer will delay before advancing to the next print line.
(C2 DLY)	<i>OFF, .10, .25, .50, .75, 1-5</i>		Choose the number of seconds the printer will delay before advancing to the next print line.
(PRTACC)			Reset Print Accumulator
MENU 3. SCALE CALIBRATION SETTINGS			
DISPLAY COUNT (COUNT)	<i>.01, .02, .05, .1, .2, .5, 1, 2, 5, 10, 20, 50, 100</i>		Count set too small, readings unstable and indicator not accurate
DISPLAY UNIT (LB-KG)	<i>LB / KG</i>		Unit of measure. When changing weight unit using long form, calibration is adjusted so scale displays accurately in new display unit.
CAPACITY (CRP)	<i>85000</i>		Enter MAXIMUM weight measurable on scale.
MENU 4 – NOT USED			

SHORT FORM CALIBRATION

The Short Form Setup & Calibration procedure allows you to change “SETUP” and “CAL” numbers of indicator.

Do not attempt to calibrate scale if indicator is not reading stable weights. Calibration procedure will not fix instability, inconsistencies, or flashing "RANGE" messages.

Obtain Current Set-up and Calibration Number

Write down current SETUP and CAL numbers of your GT 400 indicator. These numbers are displayed during Self Test.

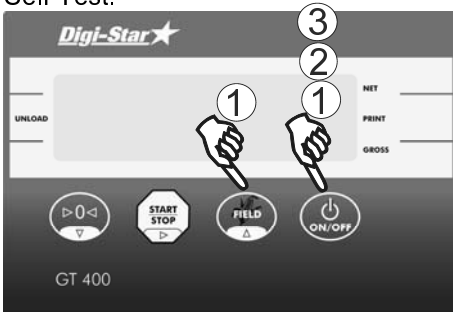

To run self test with indicator ON:

1. Press until LB symbol starts to blink. Release, then press to start Self Test.
2. Press to “pause” the Self-Test while numbers are displayed.
3. Press again to allow self-test to complete normally.

SETUP NUMBER _____

SETUP # _____

CAL # _____

Following is a list of functions that are controlled by the “SETUP” number:

- Weigh Method (*W MTHD*)
- Display Units (*LB-KG*)
- Display Counts (*COUNT*)

- Gain
- Scale Capacity

CALIBRATION NUMBER

The “CAL” number is adjusted to make scale read proper weight for different load cells and to make accuracy adjustments on a scale system. Systems should be checked with known weights and adjusted if necessary to insure accuracy. Both setup and calibration numbers are changed to convert a scale from lbs to kgs.

Calibrating Scale For Maximum Accuracy

Note: To accurately calibrate scale, you need a large amount of weight that has a known value. For best results you should have at least as much weight as largest load you plan to weigh.

Determining New Setup and Calibration Numbers

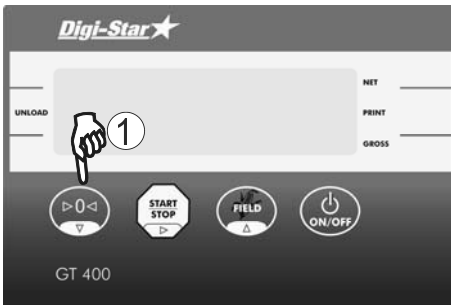

1. Press  to Zero-Balance.
2. Put KNOWN WEIGHT on scale platform and write down DISPLAY WEIGHT.

Perform following equation to find ACCURATE CAL NUMBER.

$$\frac{\text{Known Weight}}{\text{Displayed Weight}} \times \text{Existing Calibration Number} = \text{Accurate Calibration Number}$$

The setup number does not change.

Enter A New Setup And Calibration Number

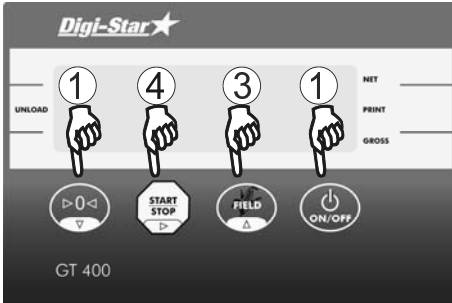

1. Press and hold and for 3 seconds to enter short form calibration.
2. The display will flash "SETUP" and then display the 6-digit setup number with the right digit flashing.
3. Press several times to increment digit to its proper value.
4. Press to advance digit left.

Repeat steps 3 and 4 for each digit as required.

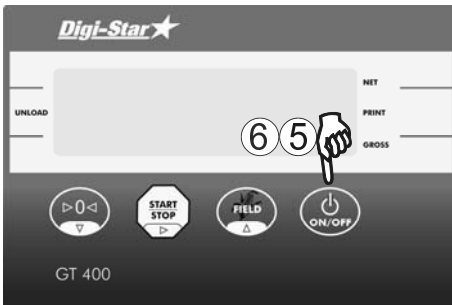

5. Press to enter new setup number and display calibration number.
- Repeat steps 3 and 4 to modify the calibration number.
6. Press to enter new calibration number and display will go back to normal.
 7. Verify the accuracy of scale.

INSTALLATION

Indicator Mounting

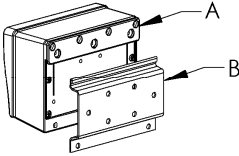
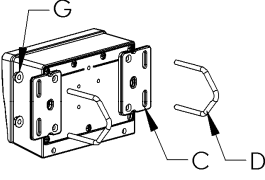
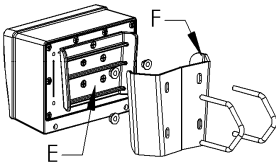
					
RAIL MOUNT		WING MOUNT		WEDGE MOUNT STANDARD	
KEY	PART NUMBER	DESCRIPTION			
A	403769	BRACKET – STR TOP MOUNT			
B	403980	BRACKET – ROBO MOUNTING			
C	403770	BRACKET – WING MOUNT			
D	405069	U-BOLT, 1/4-20 X 3.25 ZP			
E	403771	MODIFIED PLASTIC WEDGE MOUNT			
F	405124	WEDGE MOUNT BRACKET, INCLUDES U-BOLTS & NUTS			
G	405084	NUT, 1/4-20 TOP LOCKING FLANGE			

Optional Ram Mounting

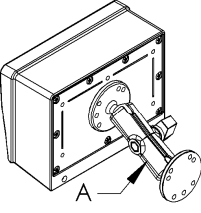
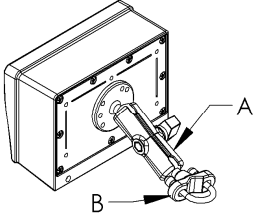
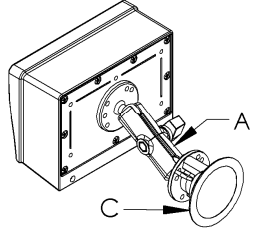
					
RAM MOUNT STANDARD		U-BOLT BASE		TWIST LOCK SUCTION CUP	
KEY	PART NUMBER	DESCRIPTION			
A	403180	RAM MOUNT			
B	403179	MOUNT BASE-1" BALL U-BOLT			
C	404230	RAM SUCTION CUP W/TWIST LOCK			

Cable Connection

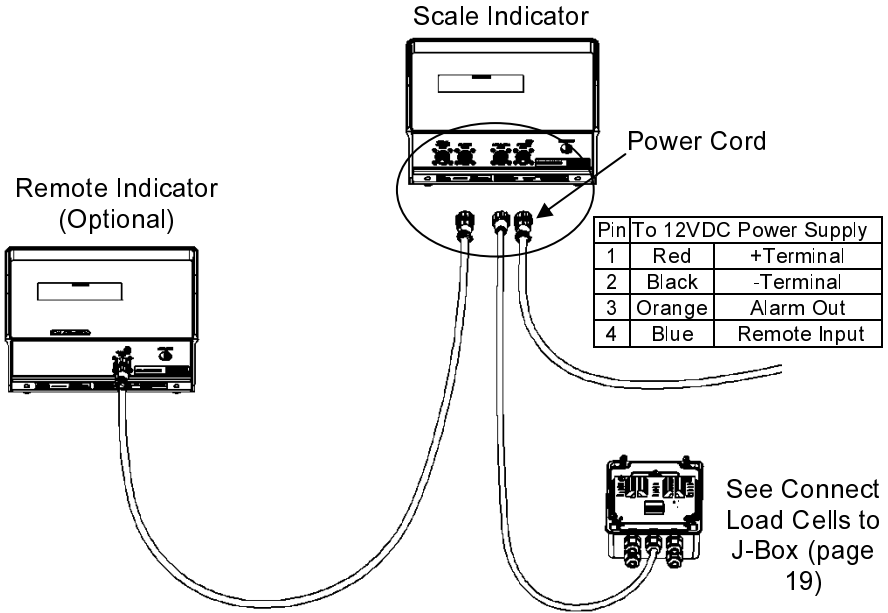

Indicator Connection Diagram

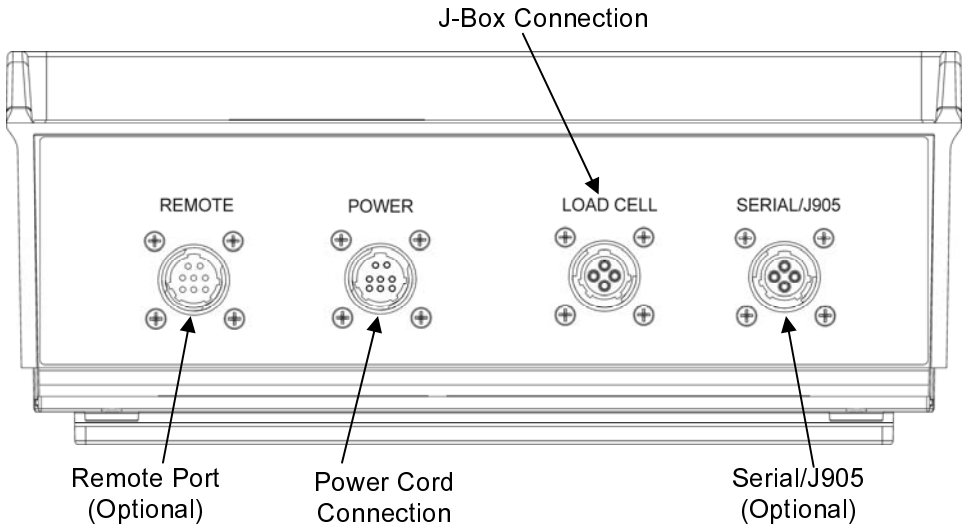

Bottom Panel Cable Connections

Connect Load Cells to J-Box

Connect load cell wires to terminal blocks. See Wire Color Key

Wire Color Key		
	Color	Description
1	White	Signal +
2	Green	Signal -
3	Red	Excitation +
4	Black	Excitation -
5	Shield	Shield

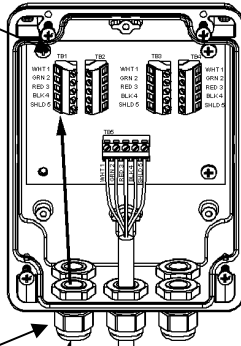

J-Box Illustrated for 4 Load Cell Installation

Tighten Nuts

J-Box Cable

Load Cell Cable

Connect to Indicator bottom Panel.

J-Box Connections

Load Cell Direction



Observe direction of arrow when installing load cell.

Indicator Calibration

If you connect an indicator to a different weighing implement, the calibration and setup number may need to change. Refer to calibration procedures (see pages 14-16) or contact your Digi-Star representative for assistance.

OPTIONAL EQUIPMENT

Data Transfer Options



Kit Data Down Loader

Allows transfer of data from indicator to PC. (Optional serial/J905 port must already be installed in indicator)

Remote Indicators



RD440 small remote display

RD2400V backlit remote display with 1.7" high numbers

RD2400V backlit remote display w/transmitter and installed receiver

RD4000 remote display

TROUBLESHOOTING

FLOW CHART

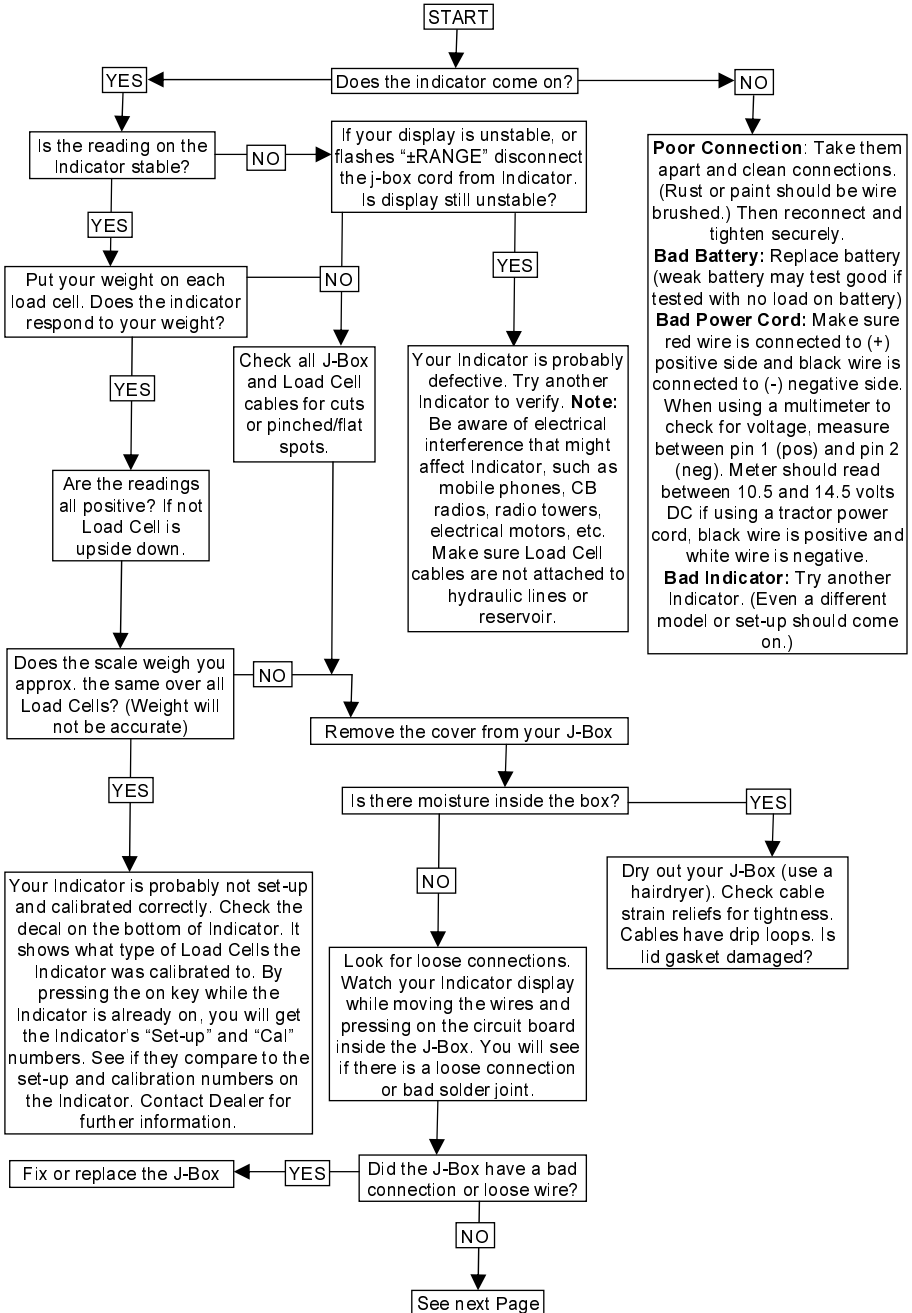

FLOW CHART

Continued

