



EZ4600

Operators Manual



Ft. Atkinson, Wisconsin USA



Panningen, The Netherlands

www.digi-star.com

TABLE OF CONTENTS

TECHNICAL SPECIFICATIONS	1
SAFETY DURING USE	2
Cleaning	2
Charging Battery and Welding	2
FEED MANAGEMENT SOFTWARE	3
INDICATOR OVERVIEW	4
OPERATION	6
Turn on Indicator	6
Zero Balance Indicator	6
Tare and Net/Gross	7
Print Key	8
DATA TRANSFER	9
USB Drive Mode	9
RF DataLink Modes	9
Indicator Data Formats	10
LOADING AND FEEDING COMPLETE LOADS MODE	10
Starting a Recipe	10
Resize Recipe Weight	11
Loading Recipe	12
Unloading to Pens	13
RECIPE AND PEN LIST MODE	14
Starting a Recipe	14
Resize Recipe Weight	14
Loading Recipe	15
Unloading Pens	15
ADVANCED COMMANDS	16
Unload Partial Pens	16
Go Back to Skipped Ingredient	16
Change Feeding Number	17
Use Arrow Keys Recipe or Pens List	17
Clear Indicator Memory	17
Re-Use Recipe/Pen Data	18
Mix Timer	18
Rotation Counter	19
Drive Ratio	19
Add a Pen to Pen List	20
COMMONLY USED DIRECT ACCESS NUMBERS (D.A.N.)	21
Pre-Alarm	21
Auto Ingredient / Manual Pen Advance	21
Auto Advance	22
Tolerance	22
Pen Tolerance	22
Delay Time	22
Scale ID or Truck ID	23
Radio Number	23

Resize Option.....	23
Change Time.....	24
Change Date.....	24
MANUAL PROGRAMMING OF RECIPES.....	25
Switch to Manual Programming.....	25
Change Entry Method.....	25
Ingredient Re-Name.....	26
Print Ingredient Names.....	26
Enter New Recipe.....	27
Change Ingredient Amount.....	28
Erase a Recipe.....	29
Review a Recipe.....	29
Printing Single Recipe.....	30
Printing All Recipes.....	30
LOADING A RECIPE.....	31
Using Amount Per Animal.....	31
UNLOADING A RECIPE.....	32
OTHER FUNCTIONS.....	33
Hold.....	33
Using Dimmer Option.....	33
MENUS AND CALIBRATION.....	34
RE-CALIBRATING YOUR SCALE.....	37
Get your Calibration Number.....	37
Enter New Calibration Number.....	38
Change Setup and Calibration Numbers.....	38
INSTALLATION.....	39
Indicator Mounting.....	39
Cable Connection.....	40
Indicator Connection Diagram.....	40
Bottom Panel Cable Connections.....	40
Connect Load Cells To J-Box.....	41
Load Cell Direction.....	41
OPTIONAL EQUIPMENT.....	42
Cab Control (Wireless).....	42
Rotation Counter Sensor.....	42
Transmitter/Receiver.....	43
Remote Indicators.....	43
TROUBLESHOOTING.....	44
LEGAL-FOR-TRADE CERTIFICATION.....	46
Legal for Trade Features.....	46
Sealed to Prevent Unauthorized Modifications.....	47

All rights reserved. Reproduction of any part of this manual in any form whatsoever without Digi-Star's express written permission is forbidden. The contents of this manual are subject to change without notice. All efforts have been made to assure the accuracy of the contents of this manual. However, should any errors be detected, Digi-Star would greatly appreciate being informed of them. The above notwithstanding, Digi-Star can assume no responsibility for errors in this manual or their consequence.

© Copyright! 2008 Digi-Star, Fort Atkinson (U.S.A.).

TECHNICAL SPECIFICATIONS

SIZE

10.25" long x 8.0" high x 4" wide
(260mm x 200mm x 100mm)

WEIGHT

4.0 lbs (1.8 Kg)

HELP MESSAGES

Context sensitive help messages in 10 languages
Long messages are scrolled

TRANSDUCER EXCITATION

8 volts D.C. Nominal
Capable of driving ten 350 Ohms transducers
Short circuit proof

ATC

Auto Temperature Compensation of the internal circuitry for high accuracy weighing measurements

TRANSDUCER SIGNAL

Compatible with transducers having full scale indicator output of 0.25 mv/v to 3.0 mv/v

"AUTO RANGE"

(Selectable) To increase display counts at weight values of 300 and 600 display counts.

CONNECTOR

AMP plastic weather resistant circular connector. Gold contacts.

POWER REQUIREMENTS

10.5 to 16.0 V.D.C.
160 mA nominal with four 350Ω L.C.

SET UP AND CALIBRATION

Via front panel

GROSS RANGE

999,999 max. display

LOW BATTERY WARNING

Enabled at 10.5V nominal

POUND/KILOGRAM

Selectable

DISPLAY

STD EZ 6 Digit LCD 1.2" high
EZ VIEW 6 Digit LCD 1.7" high

DISPLAY RESOLUTION

.01, .02, .05, .1, .2, .5, 1, 2, 5, 10, 20, 50, 100

DISPLAY UPDATE RATE

Selectable: 1, 2, 3, 4 times/sec.

MAX. DISPLAY RESOLUTION

Adjustable to 40,000 counts max.

ZERO TRACKING

Selectable, On/Off

SPAN ACCURACY

$\pm(,1\% + ,005\% / ^\circ\text{F})$ or $(,1\% + 0,009\% ^\circ\text{C})$ full scale ± 1 output count

MOTION DETECTION

Selectable, On/Off

ZERO ACCURACY

$(,005\% / ^\circ\text{F})$ or $(0,009\% ^\circ\text{C})$ full scale ± 1 output count for 0.5 mv/v transducer

ENVIRONMENTAL ENCLOSURE

IP65, IEC 529

WEIGH ALGORITHM

Front panel selectable digital filters to optimize performance
(General, Slow, Fast and Lock-on)

HOLD MODE

Used in mobile applications to stabilize displayed weight while moving the scale

NON-VOLATILE MEMORY

EEPROM for balance

OPERATING TEMP

-29°C to 60°C -20°F to 140°F

REMOTE INPUTS

Tare / Advance Recipe / Re-enter Preset

SAFETY DURING USE



Caution

Cleaning

Do not use running water (high pressure cleaners, hoses) to clean the indicator.

Charging Battery and Welding

Disconnect all cables from the weighing indicator before charging the battery or welding on the machine. If cables are left connected, the weighing indicator and connected load cells could be damaged.

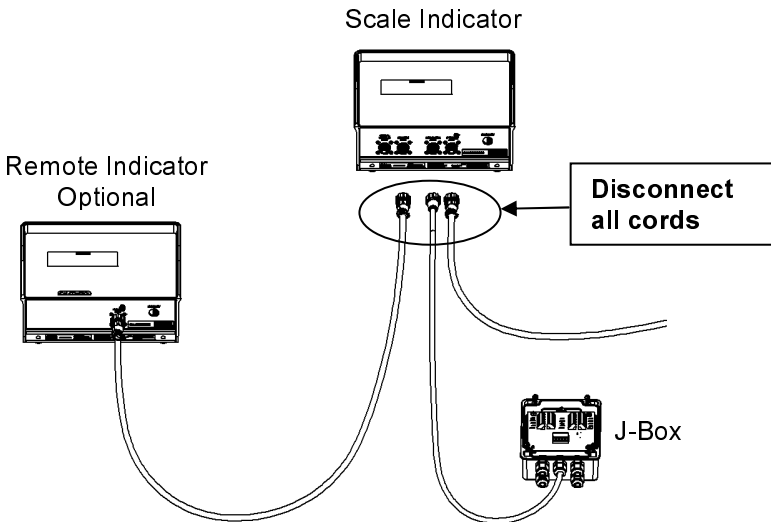

FEED MANAGEMENT SOFTWARE



TMR Tracker is a full-featured Windows based feed management system. TMR tracker also offers operators additional management tools including: Operator control, pen review, online feed data exchange with nutritionists, ingredient tracking and numerous reports. TMR Tracker is an indispensable management tool for forward thinking operations.





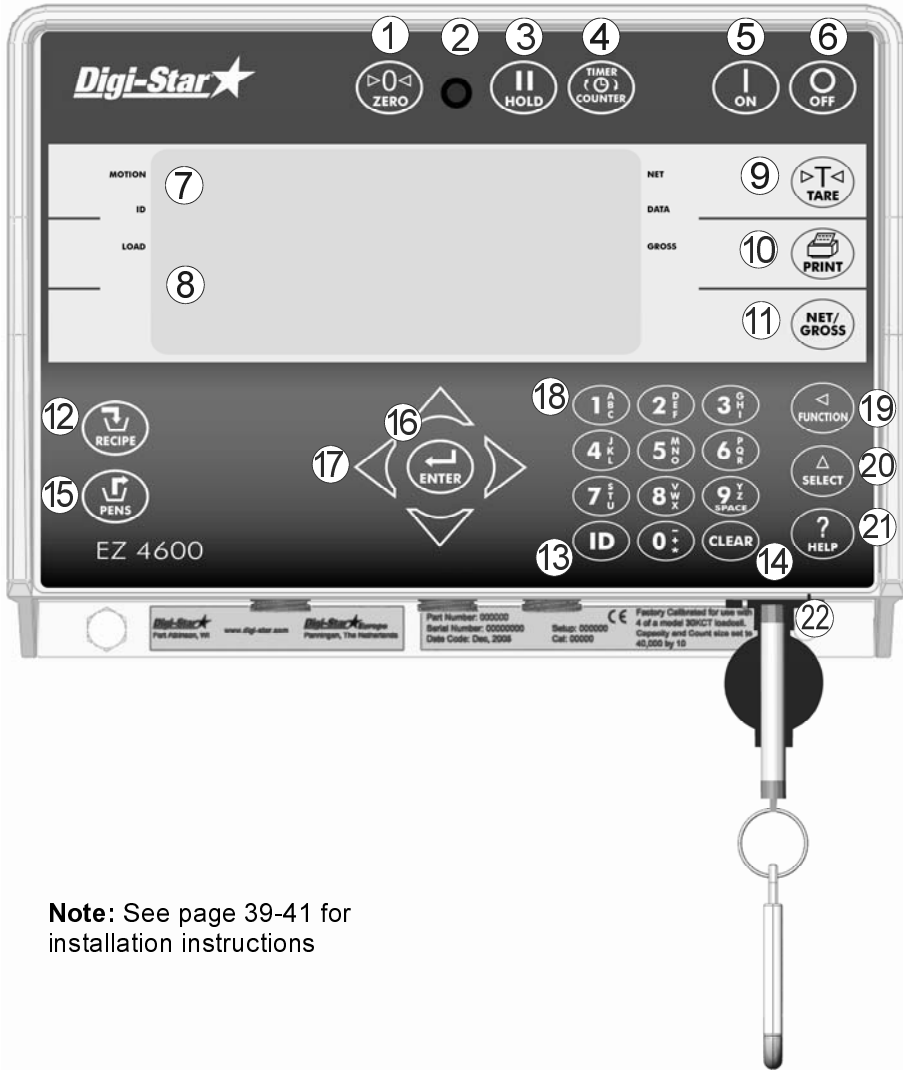





For additional information go to www.tmrtracker.com

INDICATOR OVERVIEW



Note: See page 39-41 for installation instructions

- ① -press and hold for 3 seconds to zero balance indicator.
- ② Pre-Alarm Light – Flashes and alarm sounds when weight is within preset limit. See page 21.
- ③ – holds displayed weight when moving machine.
- ④ – selects timer or rotation counter feature.
- ⑤ - turns indicator on.
- ⑥ - turns indicator off.

- ⑦ Upper Display Window – Displays current actions.
- ⑧ Lower Display Window – Lists 3 lines (i.e. ingredients, recipes, pens).
- ⑨  - temporary zero (Net Mode).
- ⑩  - records to memory or prints displayed weight.
- ⑪  - toggles between Net and Gross weights.
- ⑫  - selects recipes in memory.
- ⑬  - enter user number and feeding number. Any number can be used for user until number assigned by feed management software.
- ⑭  - Clear (backspace).
- ⑮  - press in List Mode to begin pen unloading. See page 15.
- ⑯  - accepts change or proceeds to next item.
- ⑰ Directional Arrows - moves through list of information.
- ⑱ Keypad – inputs numbers or letters as required.
- ⑲  - performs the task displayed by select.
- ⑳  - displays additional tasks.
- ㉑  - press for additional information.
- ㉒ USB Drive – Used for data transfer between computer and indicator.

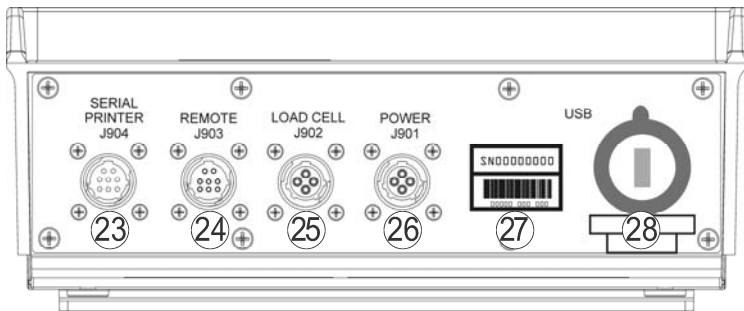

- ㉓ Serial/Printer Port – optional, to communicate with computer and other digital input/output devices.
- ㉔ Remote Port – optional, for remote display.
- ㉕ Load Cell Port– for J-Box cord.
- ㉖ Power Port – for power cord.
- ㉗ Serial Number Plate – Serial Number of indicator.
- ㉘ USB Drive Port– for USB Drive insertion. Insert USB Drive to upload/download data.

OPERATION

Turn on Indicator



1. Press .

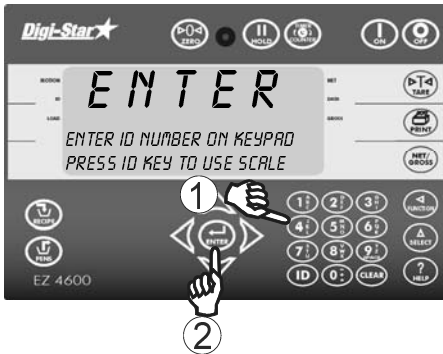

1. Enter ID Number if required.
2. Press .

1. Enter Feeding Number (only required 1st time in loads mode).
2. Press .

Zero Balance Indicator



1. Press and hold  for 3 seconds to zero balance indicator.
2. Flashing arrow points to gross next to the display window, indicator ready to weigh.

Tare and Net/Gross

Tare is a temporary zero (Net Weight) to display total weight (Gross Weight) Press **NET/GROSS**.



1. Weight displayed, press **TARE** sets zero weight.



2. Display reads zero and flashing arrow on side of display points to NET.



3. Add more weight, display reads added weight value.



- To show total of original weight of 4000 pounds plus added 300 pounds, press **NET/GROSS**, flashing arrow points GROSS.

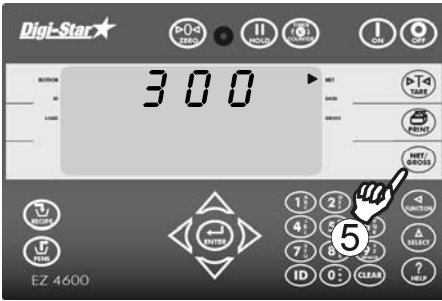

- Press **NET/GROSS**, 300 pounds is displayed and flashing arrow points NET.

Print Key

Note: Optional serial port must be installed for printing.



- Press **PRINT**. Indicator sends data to printer or PC.

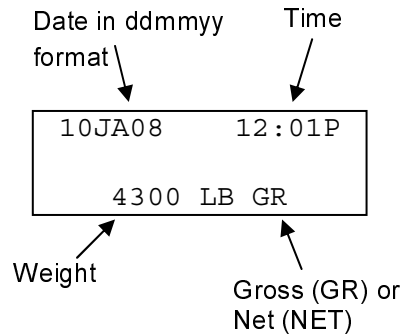

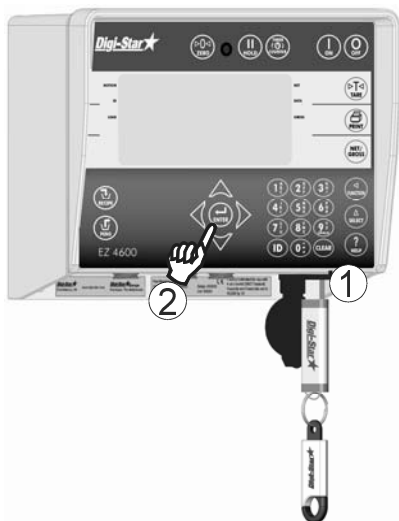

DATA TRANSFER

USB Drive Mode



To upload data:
1. Insert USB Drive.



2. Press .

Note: If indicator displays *uncompleted data in memory*, press  to overwrite *uncompleted data*.

Remove USB Drive when transfer complete.

To download data:
Insert USB Drive, indicator automatically sends data to USB Drive. Remove USB Drive.

RF DataLink Modes

Operation	Message
DataLink connects with indicator	←PC→
DataLink sends data to indicator	DL←IN
Indicator receives data	<i>ALL FEED LINES RECEIVED -PRESS RECIPE KEY TO CONTINUE</i>
Data complete, indicator sends data to DataLink	←PC→
Data sending	DL→OUT
To send data to PC if operator does not complete all feeding at end of feeding schedule. Press  until display shows message (right column), press  to perform transfer.	EZ→PC
The indicator marks uncompleted data as completed and sends feeding data to DataLink.	

Note: After sending, uncompleted data is erased.

Note: Indicator may also be manually programmed, see page 25 for instructions.

Indicator Data Formats

Data sent to indicator in two formats:

Complete Loads Mode: Each load built by PC software. It assigns pens to a recipe and builds exact load for pens.

Recipe and Pen List Mode: PC software sends recipe data and pen data in two different fields. Operator selects recipe to build and pen deliveries.

LOADING AND FEEDING COMPLETE LOADS MODE

Starting a Recipe



1. Press .



1. Indicator scrolls feeding number, first recipe and pen number. Recipes listed below.

2. Press  and  to find desired recipe.

3. Desired recipe in upper display line, press .

Resize Recipe Weight

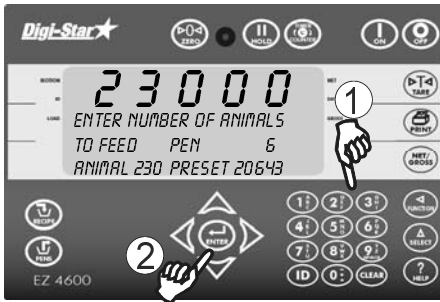

Indicator gives option to resize pen load weight.

1. Enter new weight or keep original weight.
2. Press .



Note: Press  to resize by number of head in pen.

Note: Press  to accept pen values without resizing.

Note: If indicator warns resized amount is over capacity, press  to override.

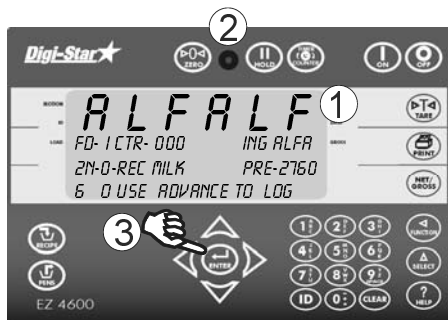
Loading Recipe



1. First ingredient weight flashes in upper display. Load ingredient.
2. Weight approaches zero, alarm will flash and sound.
3. a. Manual Advance: Weight reached, press  to accept. Press  again to start next ingredient.
- or
3. b. Auto Advance: When preset weight reached, indicator advances to next ingredient.

Displayed when in load or unload mode.

Line 1:

feeding number: *FD-2*

number of rotations during pen delivery: *CTR-000* (RC option only)

pen name: *PEN-1*

Line 2:

zone number: *ZN-1*

name of recipe: *REC-PREFRE*

call weight of pen: *PRE-1200*

Line 3:



gross weight: *G-10000*

Instruction data: *USE ADVNCE TO LOG*

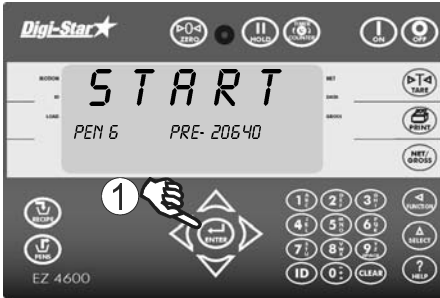
Unloading to Pens



Ingredients loaded, indicator displays first pen to unload.



1. Manually Advance: press  to go to pen. When weight reached press  to accept. Press  again to start next pen.

or

1. b. Auto Advance: When preset weight reached, indicator advances to next pen.

Note: Do not press .

Note:

If different pen needed press  or  to find desired pen.

Press  for pen delivery.

Last pen complete, indicator displays: "RECIPE COMPLETE"

RECIPE AND PEN LIST MODE

Starting a Recipe

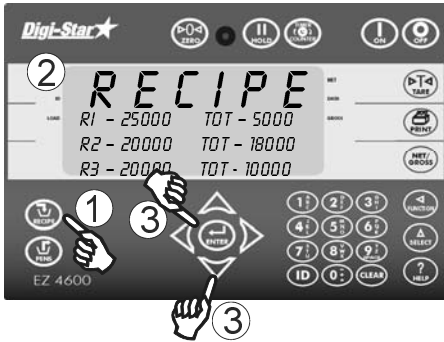

1. Press .

2. Display reads:



Example:

Line 1: *RECIPE R1*

Line 2: *R1 - 25000 TOT- 50000*

Line 3: *R2 - 20000 TOT-18000*

Line 4: *R3 - 20000 TOT- 10000*

3. Press  and  to select recipe,  to start.

Resize Recipe Weight

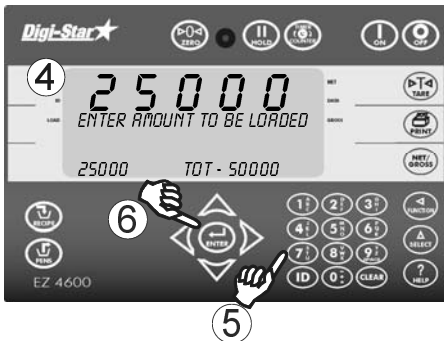

Indicator will display: *RESIZE*, then the resize weight.

4. Display reads:

Example:

Line 1: *25000*

Line 2: *ENTER AMOUNT TO BE LOADED*

Line 3: (No Data)

Line 4: *R1 - 25000 TOT- 50000*

5. Enter the amount to build in this load.

6. Press .

Loading Recipe



1. First ingredient and weight flash in upper display. Begin loading ingredient.
2. Weight reached, alarm will flash and sound.
3. a. Manual Advance: Weight reached, press . Press to start next ingredient.
- or
3. b. Auto Advance: When preset weight reached, indicator advances to next ingredient.

Unloading Pens

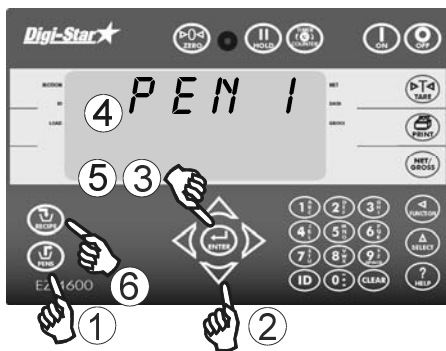

1. When ingredient loading complete, display reads "RECIPE COMPLETE". Press . Indicator displays unloading pens.
2. Press or to select desired pen.
3. Press .
4. Pen and weight displayed, begin unloading to pen.
5. a. Manual Advance: Weight reached, press to accept. Press again to start next pen.
- or
5. b. Auto Advance: When preset weight reached, indicator advances to next pen.
6. When unloading is complete press to start next recipe.

ADVANCED COMMANDS

Unload Partial Pens

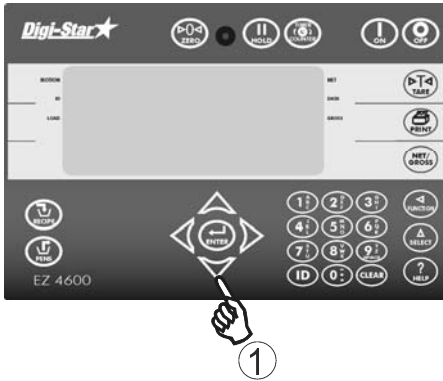

1. Press  to advance to next pen without finishing current pen.



Note: If pen tolerance is set and feeding stopped before preset weight reached, alarm sounds, indicator displays:

*PEN UNDERFERD - PRESS PRINT
TO REMOVE PEN FROM LIST-
PRESS ON TO KEEP PEN*

See page 22 for Pen Tolerance set-up.

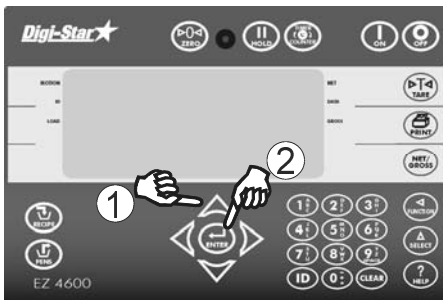
Go Back to Skipped Ingredient



1. Press  or  to move back.
2. Press .

Note: Ingredient weight changed more than 4 display counts cannot restart that ingredient.

Example: If minimum display change is 10 lbs/kgs, more than 40 lbs/kgs, cannot restart that ingredient.

Change Feeding Number

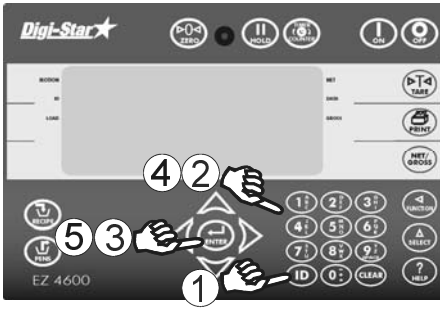

1. Press **ID**.
2. Enter user number.
3. Press **ENTER**.
4. Enter feeding number (1-9).
5. Press **ENTER**.

Use Arrow Keys Recipe or Pens List



1. Press **←** or **→** to move list three lines at a time.

Clear Indicator Memory



1. Press **OFF**.
2. Press and hold **CLEAR**.
3. Press **ON** while holding **CLEAR**
indicator reads:

ON=CLEAR CLEAR=REUSE NET=EXIT.





Release **CLEAR**.

4. Press **ON** to erase feeding memory.





Re-Use Recipe/Pen Data



1. Indicator .
2. Press and hold .
3. Press  while holding  indicator scrolls:

ON=CLEAR CLEAR=REUSE NET=EXIT.

Release .

4. Press  again to re-use recipe and pen data.





Note: When re-using data stored in indicator, it takes recipe and pen information and removes completed weights loaded or unloaded and marks them undone. It will not accumulate data day to day. Download data to USB Drive before re-using recipe and pen data stored.

Note: For continuous re-use, set D.A.N. 466 to on. See page 37.

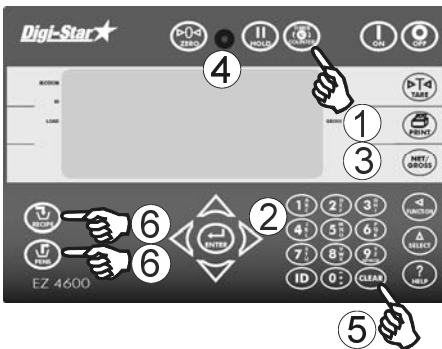
Mix Timer

The mix timer allows the operator to set a timer to alert the operator when the mixing is completed. This can be manually entered or entered as part of the recipe using the TMR TRACKER or other software package.



1. Press .
2. Use the numeric keypad to enter the amount of time.
3. Press .
4. The Mix Timer will begin to count down. When it reaches zero, the alarm light and buzzer will turn on.
5. Press  to enter the weighing mode.
6. Press the  or  key to re-enter the batching mode.

Rotation Counter

The rotational counter is used much like the timer. It allows the indicator to count the number of revolutions of a mixer shaft and notifies the operator when a set count is reached.

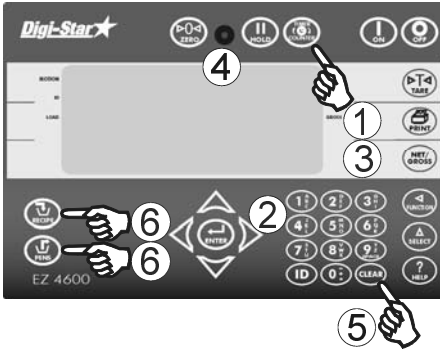

1. Press **(TIMER (0) COUNTER)**.
2. Use the numeric keypad to enter the number of rotations.
3. Press **(TIMER (0) COUNTER)**.
4. The Rotation Counter will begin to count down. when the counter has reached zero, the alarm light and buzzer will turn on.
5. Press **(CLEAR)** to turn off the alarm and enter the weighing mode.
6. Press the **(RECIPE)** or **(PENS)** key to re-enter the batching mode.

Drive Ratio

Drive ratio is number of turns seen by sensor divided by number of mixing rotations.





1. Enter **422** and press **(SELECT)** to enter drive ratio value.
2. Press **(ON)**.

Add a Pen to Pen List



1. Enter pen name or number.

2. Press .

3. Press .



1. Press  or  to find desired recipe.

2. Press .



1. Enter amount to unload to pen.

2. Press .

1. Enter number of animals / pen.

2. Press .



1. If zones are active display reads:

"ENTER ZONE 0-9"





2. Press .

COMMONLY USED DIRECT ACCESS NUMBERS (D.A.N.)

Pre-Alarm

Select weight or percentage method, enter value to activate early warning indicator reaching preset.





1. Enter **401** and press .
2. Press  again to change between WEIGHT and PERCENT.
3. Press .
4. Enter Pre-Alarm value. Press .

Auto Ingredient / Manual Pen Advance

Ingredients automatically advance, Pens manually advance.



1. Enter **461** and press .
2. Press , choose on/off.
3. Press .



Auto Advance

Allows hands free operation of programmed recipes. When auto advance feature activated, indicator automatically advances to next ingredient once tolerance, and delay time requirements met.

Tolerance

Sets weight “window” to accept loaded weight before auto advance.



1. Enter **442** and press . Press  again to choose desired percentage. Percentage settings: OFF, 0.5, 1 - 5, 7, or 10.



2. Press .

Note: OFF setting always advances after ingredient amount reached.

Pen Tolerance

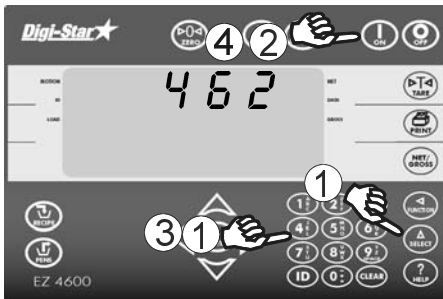
Available in List Mode Only.



1. Enter **462** and press . Press  again to choose weight or percent.

2. Press , screen will display “PENTOL”.



3. Enter weight or percentage desired.

4. Press .

Delay Time

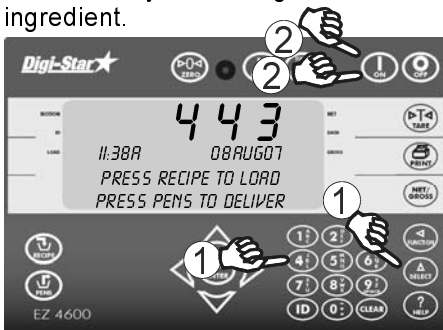
Changes time indicator, waits before automatically advancing to next ingredient.



1. Enter **443** and press . Press  again to select delay time (In seconds: Manual, 1, 2, 3, 5, 7, 10, 20, 30, or 60).



2. Press .

Note: Set to Manual prevents automatic advance.

Scale ID or Truck ID

Each indicator has scale ID.







1. Enter **108** and press .
2. Press  to erase old ID, enter new ID.
3. Press .

Note: TMR Tracker or Diet Manager, software ID must match.

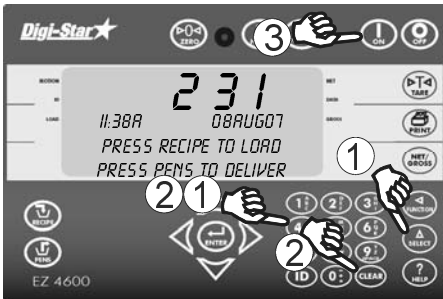
Radio Number

Used with cab control option.





1. Enter **231** and press .
2. Press  to erase number, enter new number.
3. Press .

Note: Do not use same number for two different indicators.

Resize Option





Make weight changes to pens unload weight or recipe load size.



1. Enter **448** and press , press  again, change On/Off.
2. Press .





Change Time

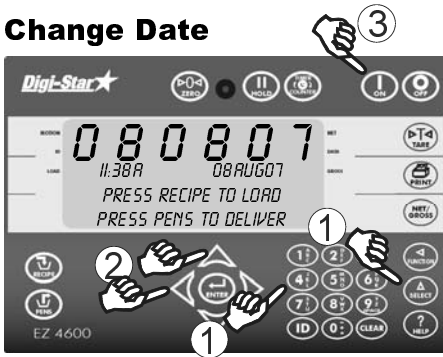

1. Enter **202** and press .
2. Press  to move cursor.
3. Press  to set time.
4. Press .

Change Date



1. Enter **204** and press .
2. Press  to move cursor. Format ddmmyy. Press  to set date.
3. Press .

MANUAL PROGRAMMING OF RECIPES

Three different entry methods for entering ingredients:

Amount Per Animal (this is the default setting)

Allows entry of ingredient amounts required for feeding one animal. Indicator calculates preset amounts required for each ingredient.

Percent (%) Per Load



Enter ingredient amounts in (%). Indicator calculates amounts for each ingredient. Total of all ingredients must equal 100% in this mode.

Amount Per Load

Allows entry of ingredient amounts required per load.



Switch to Manual Programming



1. Enter **439** and press .
2. Press  again to switch from “PC” to “Scale”.
3. Press .

Change Entry Method



1. Enter **441** press .
2. Repeatedly press  scrolls following entry methods:
 1 = Amount per Animal
 2 = Percent (%) per Load
 3=Amount per Load
3. Press  sets entry method.

Ingredient Re-Name



Ingredient names are listed in a standard table and can be changed using the following 9 steps.

1. Repeatedly press **SELECT** until *INGRNM* displays.
2. Press **FUNCTION**.
3. Press **ON** shows ingredient.
4. Press **ON** again to edit name. Display briefly shows *EDIT* and flashing cursor displayed.



5. Repeatedly press **CLEAR** erases ingredient.
6. Press "1" key once enters 1, twice enters A, three times for B, other numbers on keypad work same.
7. Pause for one second after entering a number or letter and they shift to left so a new letter or number can be added.
8. Press **ENTER**.
9. Press **NET/GROSS** to exit.



Print Ingredient Names

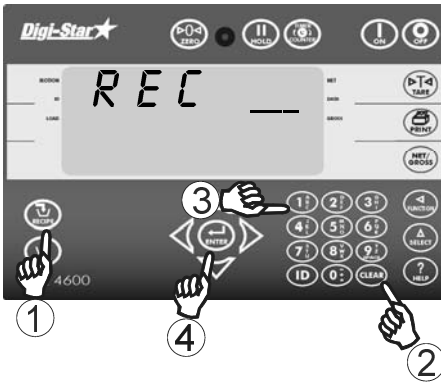

1. Press **ENTER** displays first ingredient.
2. Press **PRINT** prints total accumulations for this ingredient.
3. Press **PRINT** again prints accumulations for all ingredients currently used in all recipes.
4. Press **PRINT** again prints names for all ingredients. Ingredients not used by recipe, show unused.

Enter New Recipe





1. Press and hold  until indicator beeps and displays *PROGRAM* then displays either first recipe programmed or *REC__*. This indicates recipe number can be entered.
2. Press .
3. Enter recipe number.
4. Press  enters number.

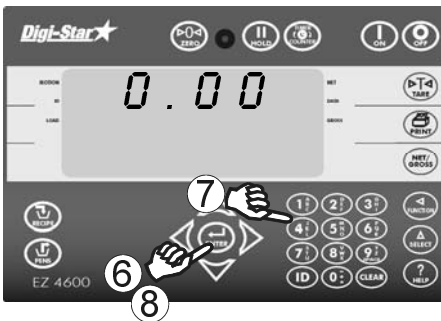

5. Press  scrolls available ingredients.



6. Press  to select ingredient on screen.
7. Enter amount of ingredient required. (see note)
8. Press  to store amount.

Note: In percent/load entry mode a 75% ingredient, for example, should be entered as 75.00 on display. 5.75% ingredient entered as 5.75.

Repeat steps 5-8 for each ingredient required.

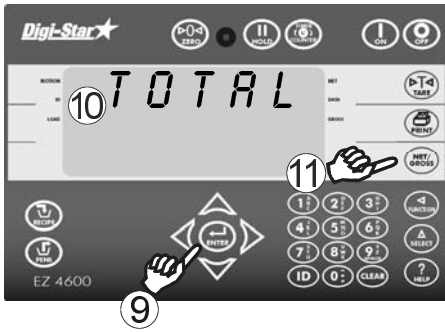

9. Press completes recipe.
10. Indicator calculates and displays *TOTAL* amount of recipe.
- Repeat steps 1 - 9 until all recipes programmed.
11. Press to exit.

Change Ingredient Amount

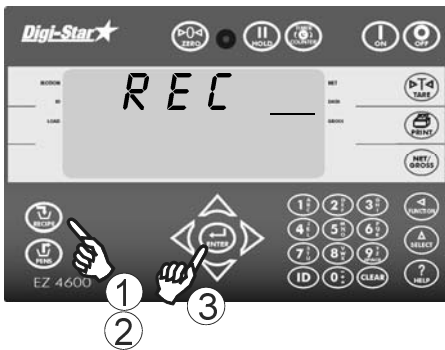

1. Press and hold until indicator beeps and displays *PROGRAM*.
2. Repeatedly press until recipe number displayed.
3. Press edits this recipe.







4. First ingredient name displayed followed by *AMOUNT*.
5. Enter new amount.
6. stores and advances to next ingredient.

Note: Only ingredient amounts can be changed. To add ingredients to recipe, first erase recipe then re-program recipe.

- Repeat steps 5 & 6 for each ingredient changed.
7. Press completes recipe.
 8. Press .



Erase a Recipe



1. Press and hold  until indicator beeps and displays *PROGRAM* followed by first recipe number.
2. Repeatedly press  until desired recipe number displayed.
3. Press and hold  message *PRESS ZERO TO ERASE RECIPE OR NET/GROSS TO EXIT* scrolls.
4. Press  erases recipe.
5. Press  exits.

Review a Recipe







1. Repeatedly press  until recipe shown.
2. Press  displays each ingredient, weight or % and total for recipe.
3. Press  exits.

Printing Single Recipe





Note: Optional serial port must be installed for printing.

1. Press  displays first recipe. Repeatedly press  displays other recipes.
2. Press  prints recipe.
3. Press .

Printing All Recipes



1. Press  displays first recipe.
2. Press  prints recipe.
3. Press  again prints all recipes in memory.

LOADING A RECIPE

Using Amount Per Animal





1. Repeatedly press  until recipe displayed.
2. Press  to accept recipe.
3. Indicator displays *LOADING RECIPE*.

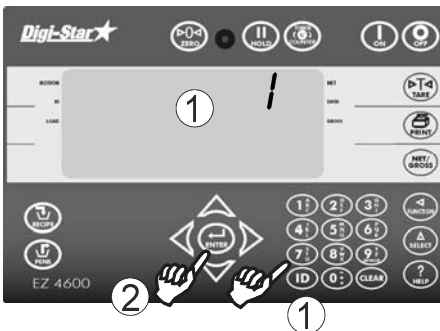

1. Indicator displays *ANIMAL*.

Note: If using percent/load, *TOTANT* will be displayed.



1. Indicator displays flashing number. Change number to amount of animals to feed.
2. Press .





1. Indicator displays ingredient to load and how much to load. As ingredient loaded indicator counts down to zero.
2. Press  to next ingredient.
(See page 22 for auto advance)

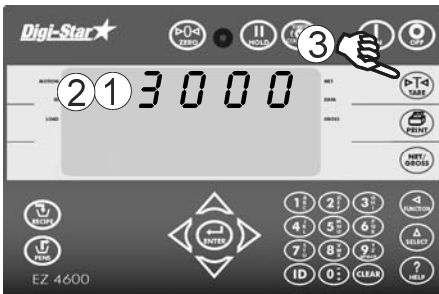

1. After last ingredient loaded, indicator displays *RECIPE COMPLETE TOTAL*.

UNLOADING A RECIPE



1. Indicator displays recipe weight.
2. Begin unloading into a pen. As recipe unloads indicator displays recipe weight remaining.
3. Press  sets temporary zero if more than one pen gets same recipe.

OTHER FUNCTIONS

Hold

Hold mode prevents displayed weight from changing while moving.





1. Press .
2. Press  returns indicator to normal.

If weight added in hold mode, press  to cancel hold.



Note: This feature is disabled on all legal for trade systems.

Using Dimmer Option



1. Repeatedly press  until **DIMMER** is displayed.
2. Press  dims backlight.

MENUS AND CALIBRATION

Enter D.A.N. and press  to display setting name. Press  again to change option value.

Press  to save setting.

SETTING [display]	D.A.N NO.	OPTIONS [displayed] BOLD=DEFAULT	DESCRIPTION
MENU 1. BASIC FEATURES IN MOST INDICATORS			
LANGUAGE (LANGRG)	101	English (ENGLISH) Dutch (NEDERL) French (FRANCS) German (DEUTSH) Italian (ITRL) Portuguese (PORT) Spanish (ESPAÑ) Danish (DANSK) Hungarian (MAGYAR) Spanish (WESTA)	Select language to be displayed.
TR HOLD (TR HLD)	107	ON/OFF	Display gross weight if TR key is held for 3 seconds.
SCALE ID SETUP (SCALID)	108	NEW EZ	Identity of scale location (truck id or Mixer number).
MENU 2. CLOCK, PRINTER, COMMUNICATIONS & ESTIMATED WEIGHT FEATURES			
TIME FORMAT (TIME F)	201	24 HR AM/PM	Select time format - AM/PM or 24 hour
1 TIME (TIME)	202	XX:XX:XX	Select key changes time, function key chooses hh:mm:ss.
DATE FORMAT (DATE F)	203	1-mm-dd 2-mm/dd/yy 3-mm/dd/yyyy 4-dd-mm 5-dd/mm/yy 6-dd/mm/yyyy 7-ddmoyy 8-ddmoyyyy.	Select date format
DATE (DATE)	204	Enter XXXXXX	Select key changes date - function key chooses mm/dd/yy.

SETTING [display]	D.A.N NO.	OPTIONS [display] BOLD=DEFAULT	DESCRIPTION
MEDIA (<i>MEDIA</i>)	217	USB DDL DATAKEY SER PC	Select media type for data storage.
SCALE NUMBER (<i>SCL NO</i>)	231		Select scale number for cab control communication
REMOTE DISPLAY (<i>RMDISP</i>)	234		Select type of remote display
MENU 3. SCALE CALIBRATION SETTINGS			
DISPLAY UNIT (<i>LB-KG</i>)	303	LB/KG	Display pounds -lb or kilograms -kg
MIMIC TYREL (<i>TC1300</i>)	321	OFF/ON	If ON -records preset weights like a TYREL TCX-1300 indicator. Indicator Tracks gross weight while batching.
MENU 4. PRESET. BATCHING & ROTATION COUNTER FEATURES			
PRE ALARM (<i>P MTHD</i>) & (<i>P-ALN</i>)	401	WEIGHT PERCNT	Select weight or percentage method, then enter a value to activate an early warning that indicator is reaching the preset.
BUZZER (<i>BUZZER</i>)	404	1-4, ON/OFF	ALARM BUZZER -allows user to turn off alarm horn.
TIMER/ COUNTER (<i>TMRCTR</i>)	421	REV TIME	Select time or mixer revolutions to decrement mix timer/counter.
DRIVE RATIO (<i>DRATIO</i>)	422	0001.00	Enter the number of input pulses that equal 1 mixer revolution.
MANUAL PROGRAMMING	439	PC/SCALE	PC: Requires a USB Drive with programming. Scale: Allows user to manually program indicator.
ENTRY METHOD (<i>E MTHD</i>)	441	1,2,3	Select batch 1-amount/animal 2-percent/load 3- amount/load
TOLERANCE	442	OFF, ,5,1-5,7,10	Select tolerance weight

SETTING [display]	D.A.N NO.	OPTIONS [display] BOLD=DEFAULT	DESCRIPTION
<i>(TOLER)</i>			percentage to accept ingredient.
INGR. ADVANCE DELAY <i>(DELAY)</i>	443	MANUAL , 1-3,5,7, 10,20,30,60	Select seconds to delay before advancing to next ingredient.
FORCE USER ID <i>(USERID)</i>	446	ON/OFF	If ON -operator must enter user ID to use indicator.
RESIZE RECIPE <i>(RESIZE)</i>	448	ON/OFF	If ON -operator can change recipe size.
TOLER OVER LOCK <i>(OVERLK)</i>	453	ON/OFF	If ON -prevents auto-advancing if preset exceeds tolerance
FEED ZONE <i>(FDZONE)</i>	454	ALL , 1-9	Select feed zone for recipe deliveries.
UNDONE RECIPES <i>(UNDN I)</i>	455	ON/OFF	If ON -displays all incomplete recipes or enable if indicator is stationary mixer/batch when using DataLink.
AUTO START PENS <i>(AUTPEN)</i>	458	ON/OFF	If ON -starts pens list after recipe is loaded in list mode format.
MANUAL PEN ADVANCE <i>(MANPEN)</i>	461	ON/OFF	If ON -overrides automatic advance for pens.
PEN TOL <i>(T MTHD) & (PENTOL)</i>	462	WEIGHT PERCNT	Select weight or percentage method, then enter pen tolerance.
PEN WEIGHT <i>(PEN WT)</i>	463	LOAD GROSS NET	Select method for displaying pen Weight - net, load, or gross.
DOUBLE KEY PRESS PREV <i>(DBKEY)</i>	465	ON/OFF	Select method ignores double pressing of keys when advancing ingr. While loading mixer.
RECIPE REMAIN ACTIVE <i>(RE-USE)</i>	466	ON/OFF	Select ON to reuse recipes.

SETTING [display]	D.A.N NO.	OPTIONS [displayed] BOLD=DEFAULT	DESCRIPTION
CALIBRATION			
SETUP NUMBER <i>(SETUP)</i>	871		Quick entry method selects weigh method 1-4lbs, 5-8 kg, gain 1-9, display counts 1-9 and capacity *1000
CALIBRATION NUMBER <i>(CAL)</i>	872		Weight displayed at 0.4mV/V for these load cells

RE-CALIBRATING YOUR SCALE

To re-calibrate your scale and make it even more accurate, document at least 3 to 6 loads of varying sizes and measure the actual weight of all loads on a certified scale.

Reading Too High

If the Indicator is reading higher than the certified scale, then the calibration number is high and should be decreased proportionally.

Reading Too Low

If the Indicator is reading lower than the certified scale, then the calibration number is low and should be increased proportionally.

Get your Calibration Number

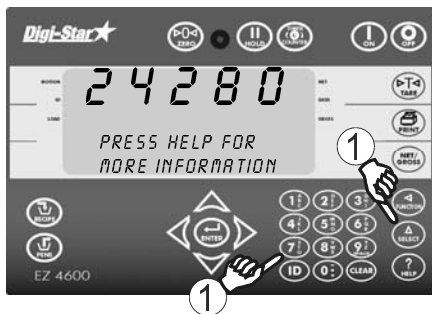

1. Enter **872** and press . The calibration (**CAL**) number will display. Example **CAL = 24280**.



$$\frac{\text{TOTAL CERTIFIED WEIGHT}}{\text{TOTAL INDICATOR WEIGHT}} \times \text{CURRENT CAL NUMBER} = \text{NEW CAL NUMBER}$$

Using the previous example your results would be:

$$\begin{array}{r} 205030 \\ 203400 \end{array} \times 24280 = 24475$$

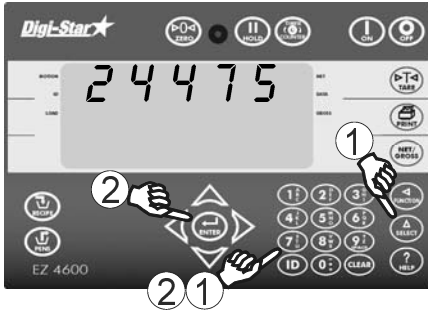
Enter New Calibration Number





1. Enter **872** and press . Existing calibration number will display.
2. Use number pad to type new number and press .

For best results, unload on level ground. Make sure no grain is lost in trucking the grain to a certified scale.

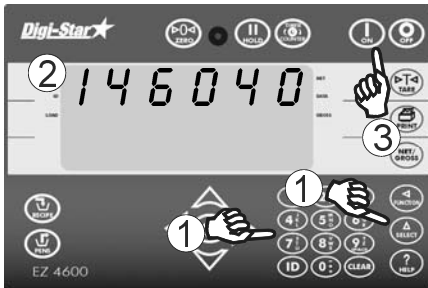
Change Setup and Calibration Numbers



1. Enter **871** and press .
2. Indicator shows *SETUP* briefly then show a 6 digit number. Enter new number.
3. Press .

Follow same procedure changes calibration number except use **872**.

INSTALLATION

Indicator Mounting

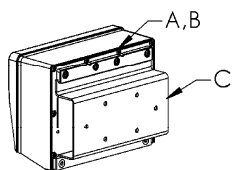

RAIL MOUNT

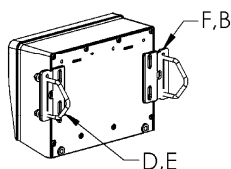

WING MOUNT

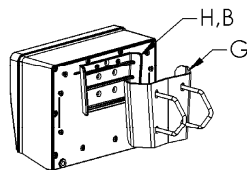

WEDGE MOUNT

KEY	PART NUMBER	DESCRIPTION
A	404353	BRACKET-EZ3 PLASTIC RAIL *
B	403780	SCR-#10 X 5/8 FHSTS BLACK ZP
C	840459	SUPPORT-HAT BRACKET
D	405069	U-BOLT 1/4-20 X 3.25 ZP
E	405084	NUT-1/4-20 TOP LOCKING FLANGE
F	403770	BRACKET- WING MOUNT *
G	405124	PACK-WEDGE MOUNT BRACKET WITH U-BOLTS & FLANGE NUTS
H	405244	EZ3 WEDGE MOUNT

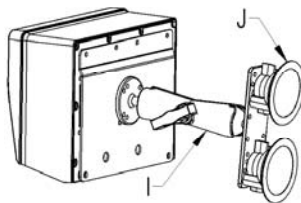

RAM MOUNT

KEY	PART NUMBER	DESCRIPTION
I	404799	RAM MOUNT FOR EZ III INDICATOR WITH HARDWARE
J	404230	RAM SUCTION CUP W/TWIST LOCK

Cable Connection

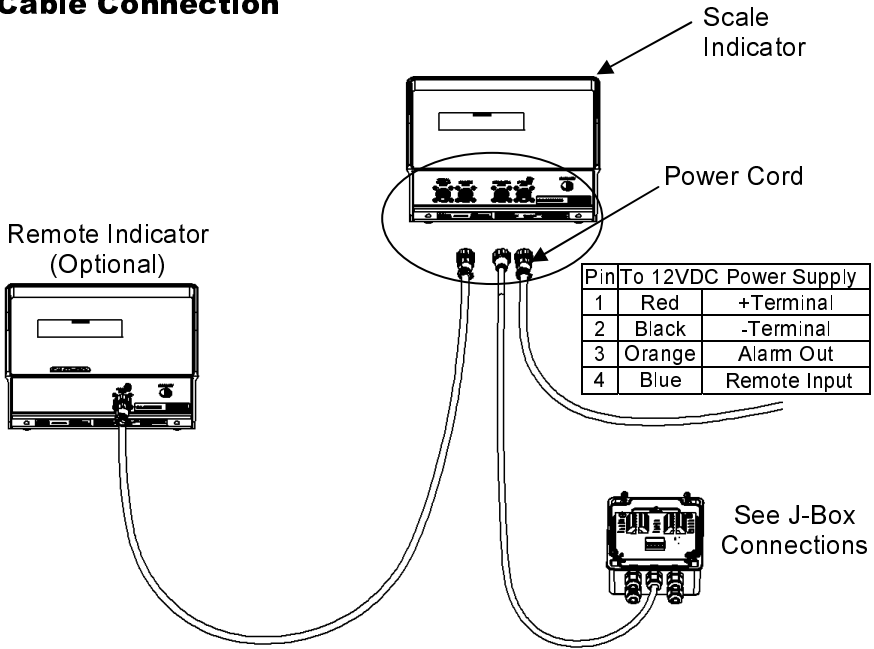

Indicator Connection Diagram

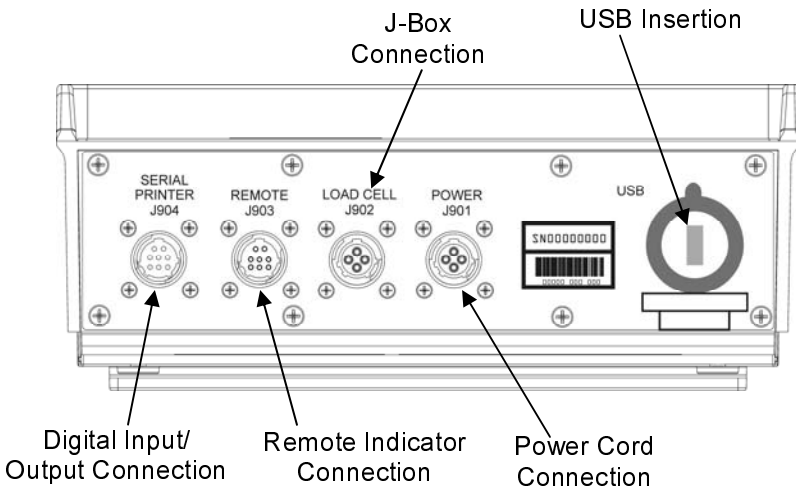

Bottom Panel Cable Connections

Connect Load Cells To J-Box

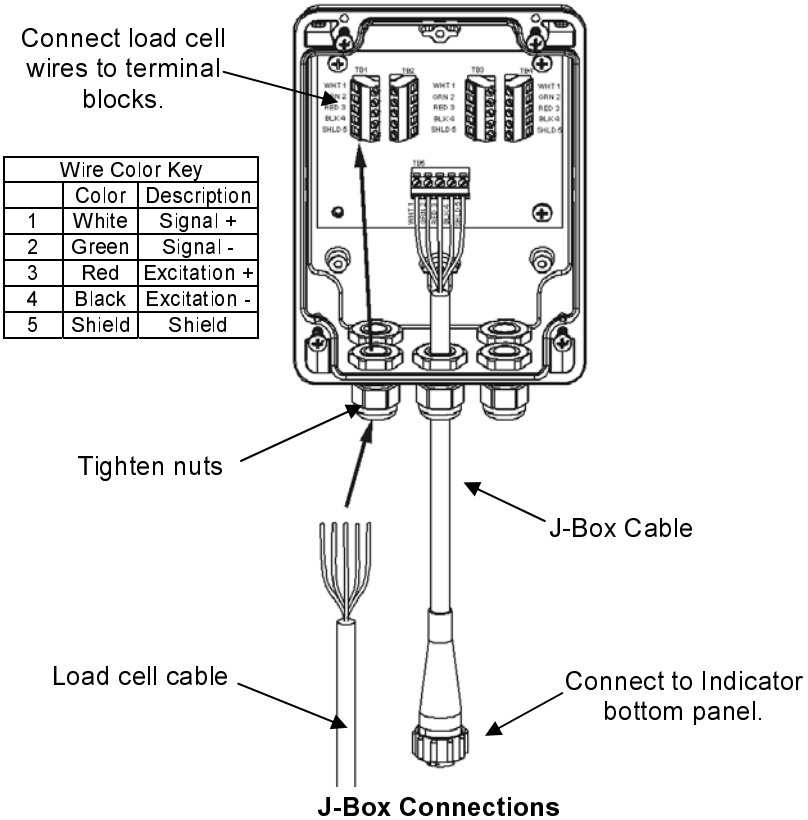

Load Cell Direction



Observe direction of arrow on load cell when installing load cell.

OPTIONAL EQUIPMENT

Cab Control (Wireless)



Features

- Wireless remote with full key control of indicator on mixer
- Mount remote in easy view of loading
- Improves loading accuracy

Functions

- Communicates with multiple mixers
- Easily call-up recipes without leaving loader

Specification

- Internally mounted 2.4 GHz radios
- Up to 1000 foot range
- 24 channels
- 12 or 24 volt DC system

Rotation Counter Sensor

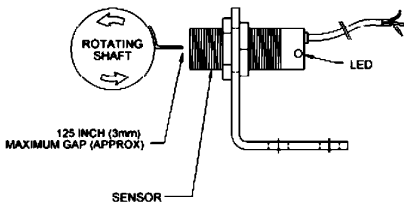

Use with EZ3600 or EZ4600 indicators equipped with rotation counter port. Sensor allows operator to program indicator to count auger or PTO rotations for accurate mix.

Transmitter/Receiver



Transmitter (shown) with factory installed receiver in indicator. Use to zero indicator from remote location. Operating range about 90 feet.

Remote Indicators



RD440 small remote display with 1" high numbers



RD2400V backlit remote display with 1.7" high numbers



RD4000 LED remote display with 4" high numbers

TROUBLESHOOTING

FLOW CHART

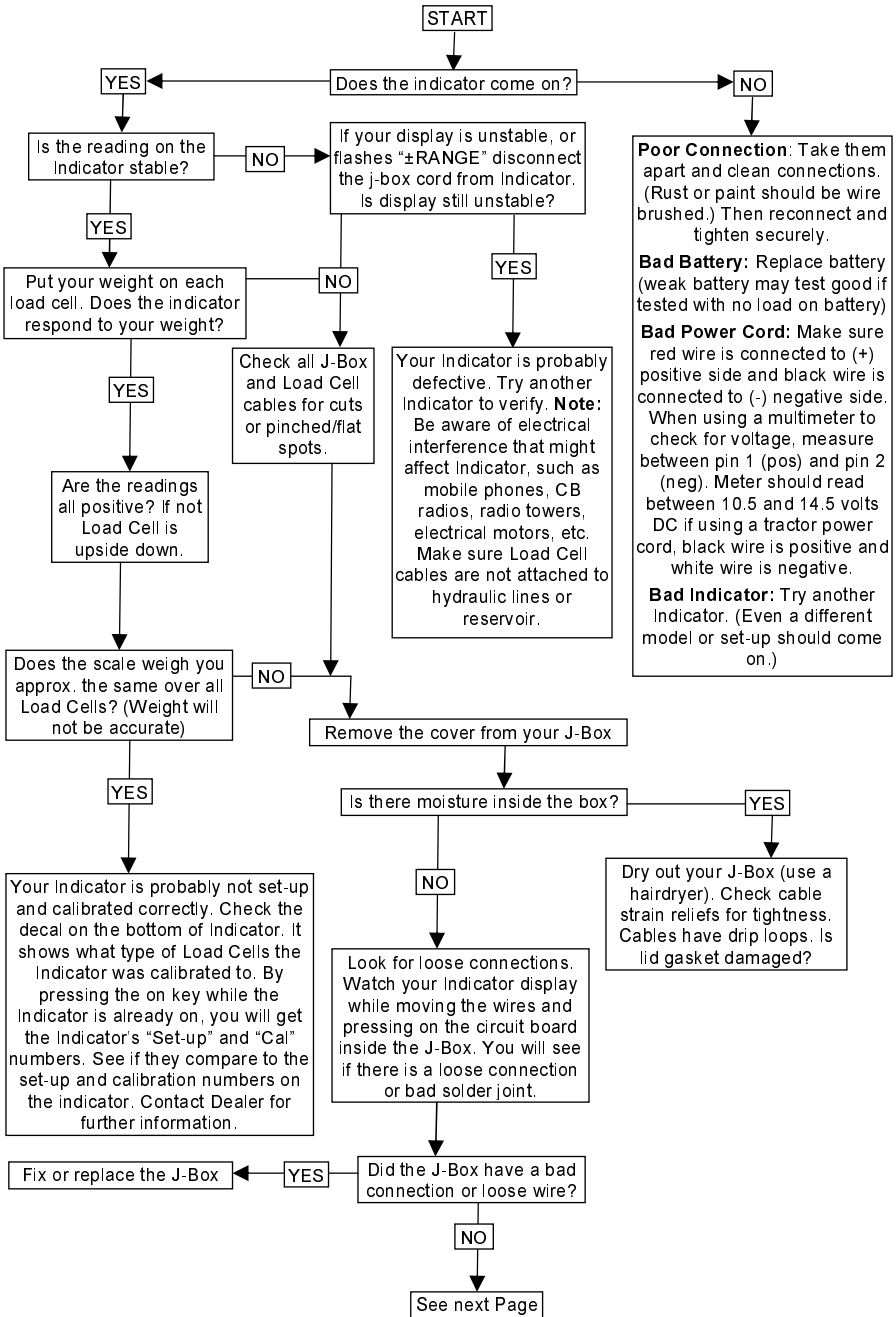

FLOW CHART

Continued

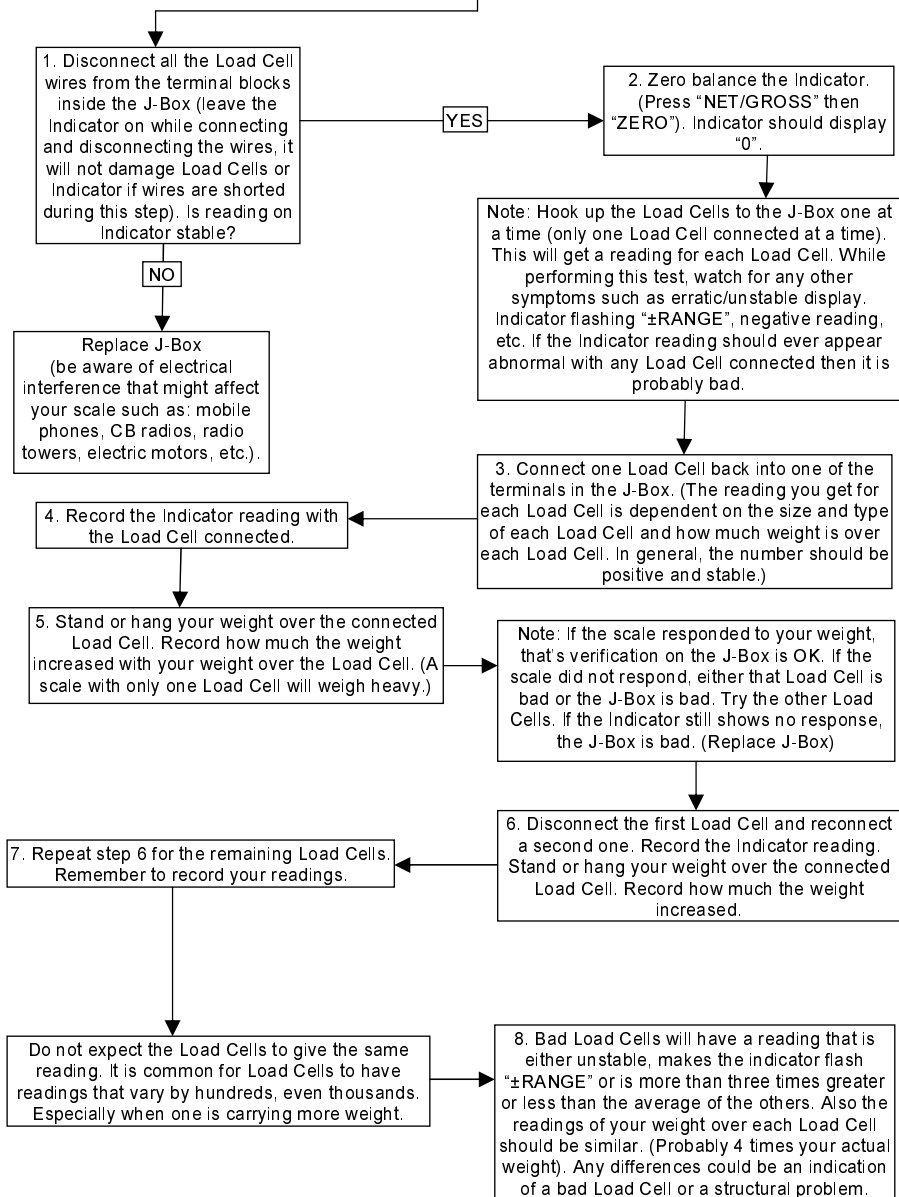

LEGAL-FOR-TRADE CERTIFICATION

United States

In the US, the Legal-for-Trade certification is regulated by the National Type Evaluation Program (NTEP). The NTEP certificate number is 08-40.

Canada

Measurement Canada is the Canadian agency that regulates Legal-for-Trade scales. The approval number from Measurement Canada is AM-5678C.

Legal for Trade Features

Digi-Star Legal-for-Trade indicators are modified to comply with US and Canadian regulatory agencies. Some of these modifications are:

Load Cell Disconnect Sensor

Indicator displays *+RANGE* or *-RANGE* without flashing when load cells are disconnected.

Hold Function

The Hold function has been disabled. (EZ3400, EZ3600 and EZ4600)

Printing

Printing weight values is not allowed while in motion, during self-calibration, or if any error conditions such as *+RANGE*, *OVRCAP* or *OVRFLW*, are active.

Lock-On Weigh Method

Lock on weigh method (for animal weighing) cannot be enabled.

Tare

Cannot tare a negative weight.

Labeling

The capacity and division information is shown on the front of the indicator.

Sealed to Prevent Unauthorized Modifications



The scale indicator is sealed by a Category 1 Audit Trail. To access the audit trail in the normal weighing mode, press and hold the “ON” key. This will display the current parameter and calibration event count values. Pressing any key will return the indicator to the weighing mode. The audit trail system is always active and cannot be altered. Audit trails are stored in flash memory and do not require batteries to maintain the audit trail values.

Changing any of the following parameters will change the Calibration event count value or parameter audit event count value. This will void your Legal-for-Trade certification unless performed by properly trained personnel.

- Setup
- Calibration
- Capacity
- Display Count
- Display Units
- Weigh Method
- Motion
- WMA1-1 through WMA2-3
- LFT Option Setting

On Legal-For-Trade Units Only

Perform the following procedure on an empty and clean machine before the unit is to be “site-certified”.

- Install the LFT indicator on the machine and connect all load cells.
- Zero/balance the scale with no load on the machine.
- Enter “871” and press . Press  to accept.